

Name _____ Period _____ Date _____

Missing Measures: Intersecting Lines 1

Find the measures of the missing angles.

1)

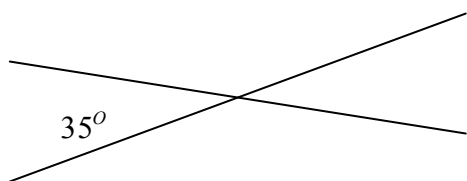

2)

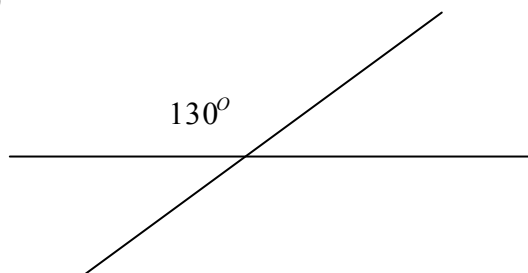

3)

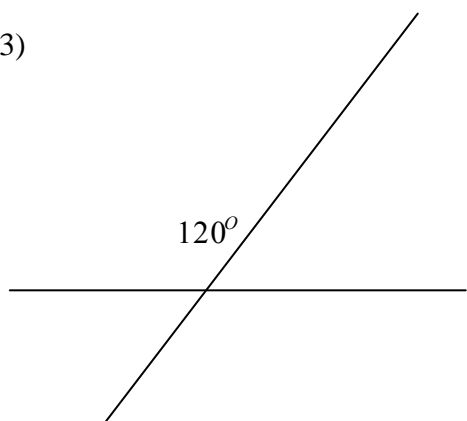

4)

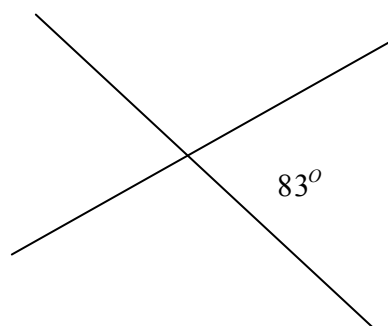

5)

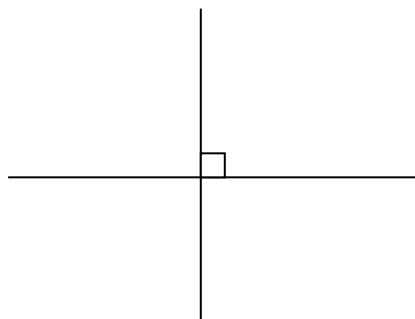

6)

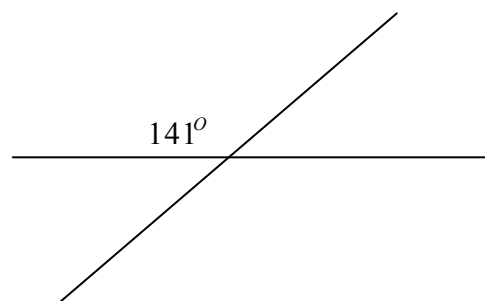

7)

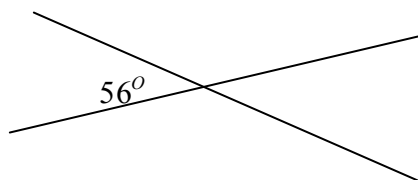

8)

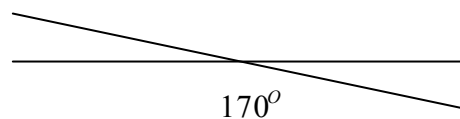

For problems 9 – 16, find the missing angles.

9)

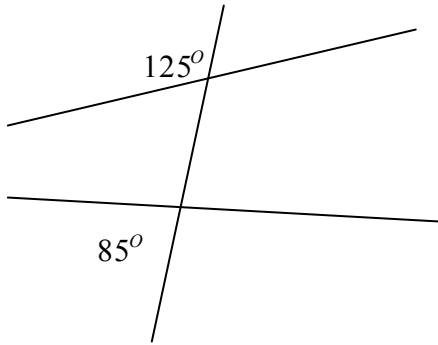

10)

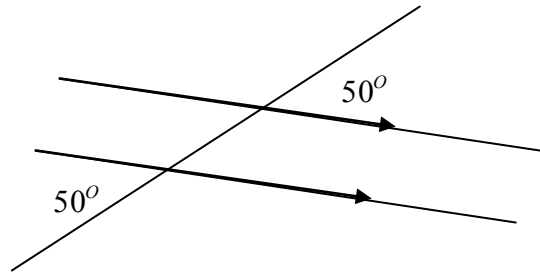

11)

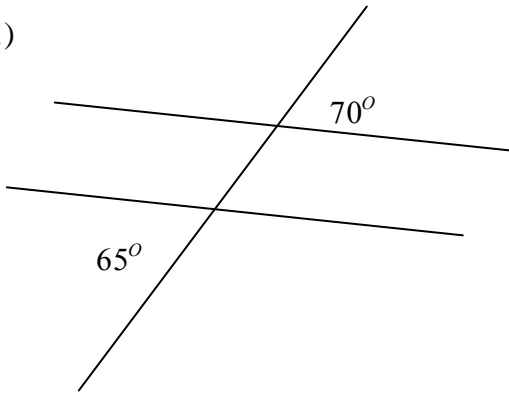

12)

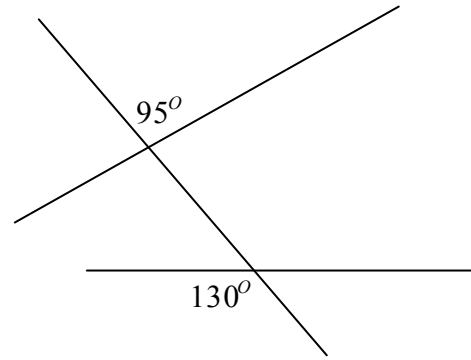

13)

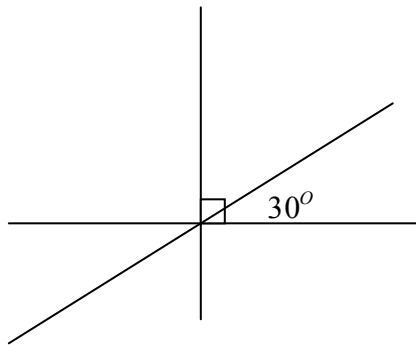

14)

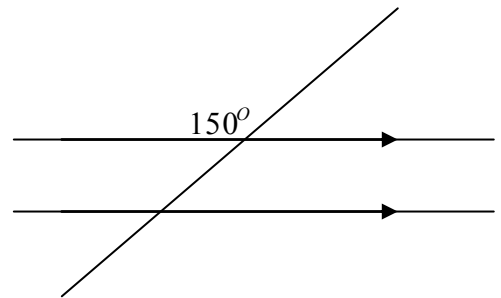

15)

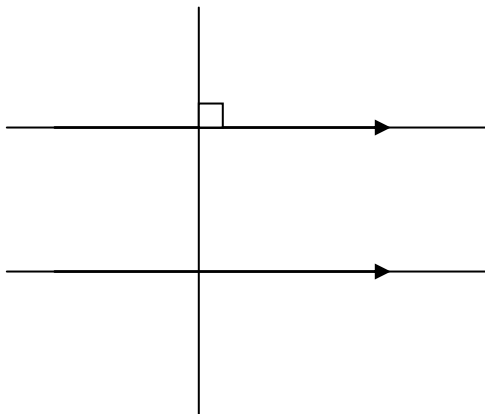

16)

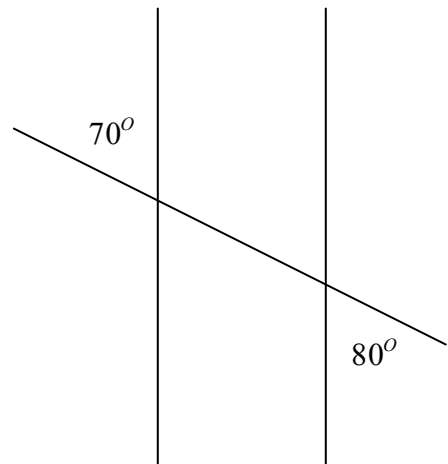

Name ANSWER KEY Period _____ Date _____

Missing Measures: Intersecting Lines 1

Find the measures of the missing angles.

1)

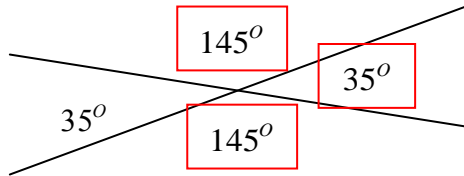

2)

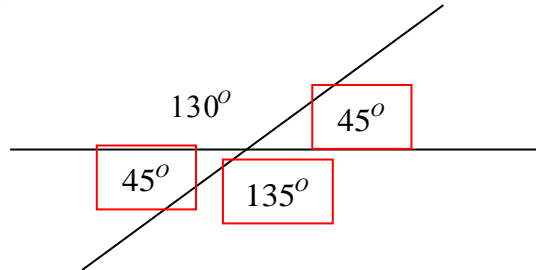

3)

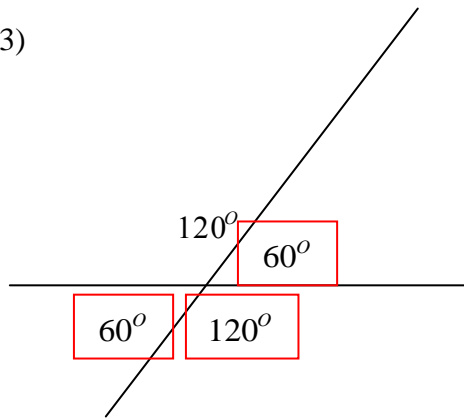

4)

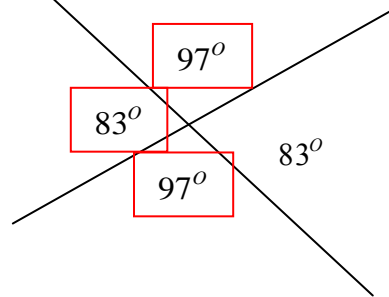

5)

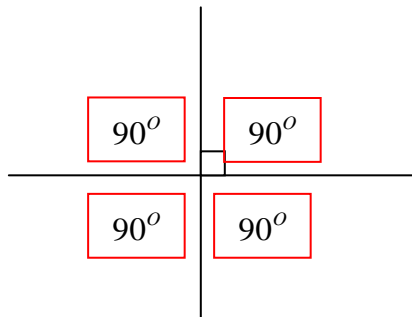

6)

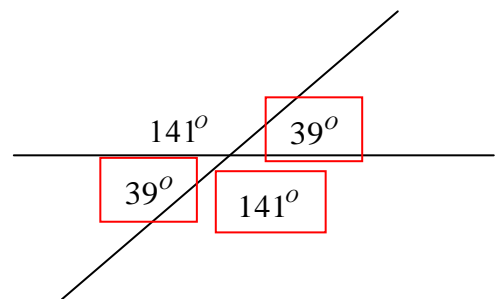

7)

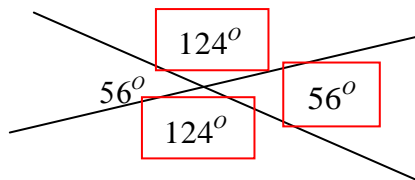

8)

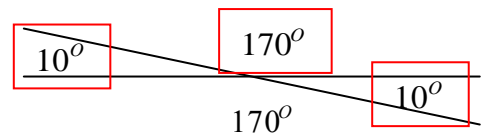

For problems 9 – 16, find the missing angles.

9)

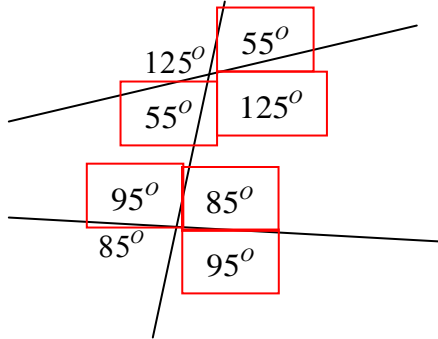

10)

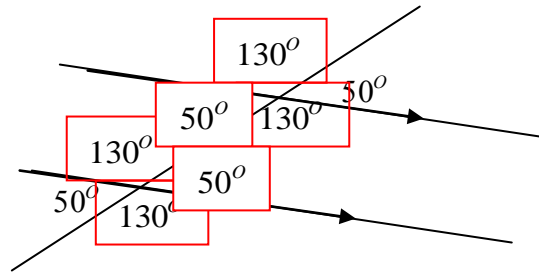

11)

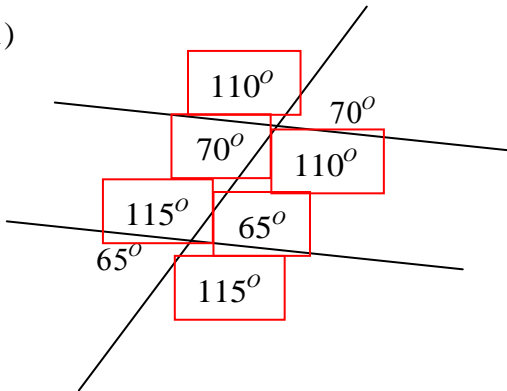

12)

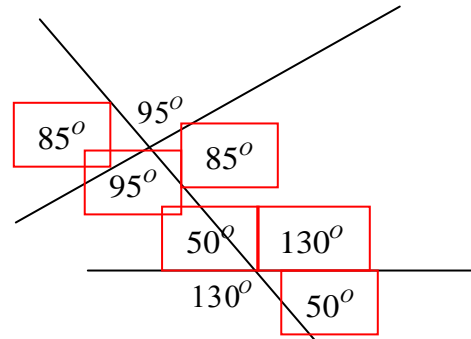

13)

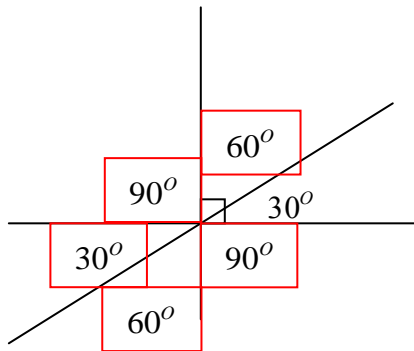

14)

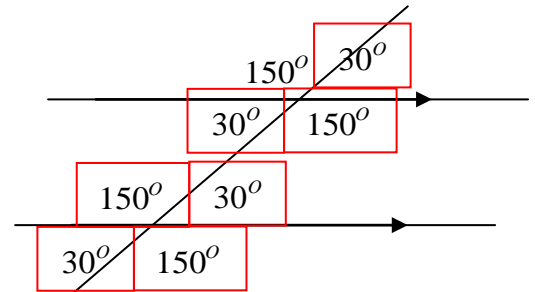

15)

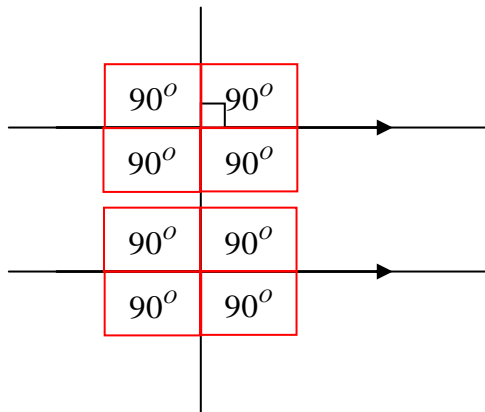

16)

